

# BIBTAG TIMING SYSTEM

## User Manual

Version 2.0 art: #40S220



Published by:  
MYLAPS B.V.  
Zuiderhoutlaan 4  
2012 PJ Haarlem  
The Netherlands

Copyright © 2017 No part of this document may be reproduced by any means without the written consent of the publisher. Whilst every care has been taken to ensure that the information in this document is correct, no liability can be accepted by MYLAPS for loss, damage or injury caused by any errors or omissions in this document. The sale of products, services of goods governed under this publication are covered by MYLAPS's standard Terms and Conditions of Sales. This product publication is provided solely for informational purposes. All hardware and software product names used in this document are likely to be registered trademarks and must be treated accordingly.

Manual revision history		
Version	Date	Amendments

Version 2.0	May, 2017	added clear & sync and redesign
-------------	-----------	---------------------------------

Product number #40S220



This device complies with part 15 of the FCC rules. Operation is subject to the following two conditions:

- (1) This device may not cause harmful interference, and
- (2) This device must accept any interference received, including interference that may cause undesired operation.



This device complies with the EMC directive 2004/108/EC and RTTE directive 1999/5/EC. A copy of the declaration of conformity can be obtained at:

MYLAPS B.V.  
Zuiderhoutlaan 4  
2012 PJ Haarlem  
The Netherlands



RoHS Compliant

This equipment has been tested and found to comply with the limits for RoHS compliant materials. These limits require manufacturers to ensure that they do not use materials or components that contain restricted substances that may be harmful to the environment.

## How to use this manual



### Search for Keywords

Search for keywords to find a topic. Press Ctrl+F on Windows or Command+F on Mac.



### Navigate Topics

View a complete list of topics in the table of contents. Click on a topic to navigate to that section



### Printing this Document

This document supports high resolution printing.

## Legends



Hints and Tips



Important



Reference

## Download options

Download the manual and install the product software from the MYLAPS Partner site.

<https://partners.mylaps.com/>

Contact MYLAPS if you do not have a partner account – [info@mylaps.com](mailto:info@mylaps.com)

## About this Manual

This manual is intended for operating and supervisory personnel and provides information on installing and operating the product.

This publication has been written with great care. However, the manufacturer cannot be held responsible, either for any errors occurring in this publication or for their consequences.

The sale of products, services of goods governed under this publication are covered by MYLAPS 's standard Terms and Conditions of Sales and this product manual is provided solely for informational purposes.

## Contents

How to use this manual.....	3
Legends.....	3
Download options.....	3
About this Manual.....	3
1. BibTag Timing system.....	6
2. Specifications BibTag System.....	10
2.1 BibTag Decoder.....	10
2.2. Modem/GPS Unit.....	10
2.3. Decoder Panel.....	11
2.4. LED Status Panel.....	12
2.5. Antenna Mats.....	13
2.6. Antenna Cables.....	14
3. The athletes.....	15
3.1. BibTag/Thin Tag.....	15
3.2. Multi Sports Tag.....	16
4. How to set up a BibTag Timing System.....	17
4.1. General.....	17
4.2. How and where to set up the BibTag Timing System.....	18
4.3. How to connect the mats and the cables.....	19
4.4. Decoder initialization – no internet used.....	21
4.4.1. Decoder initialization – internet used – recommended.....	22
4.5. Testing the signal.....	23
5. Clear and synchronize (sync).....	24
5.1. Clear before sync your decoder – no internet necessary.....	24
5.2. Sync – internet is available.....	24
6. Removal and Storage.....	25
7. Operating the BibTag Decoder.....	27
7.1. Main Screen.....	27
8. Main Screen menu.....	29
8.1. Menus.....	29
8.1.1. Markers and files.....	30
8.1.2. Timeline set up.....	33



8.1.3. General.....	36
8.1.4. Communication.....	40
8.1.5. Log.....	43
8.1.6. Memory stick (only available when USB key inserted).....	44
8.1.7. Info Screens.....	45
9. Maintenance.....	47
9.1. Introduction.....	47
9.2. Periodic maintenance schedules.....	47
9.2.2. Charge battery.....	49
9.2.3. Check/Update software.....	49
9.2.4. Calibrate battery indicators.....	50
9.2.5. Remove/Replace SIM card.....	50
9.2.6. Replace battery.....	52
9.2.7. Replace cables and antennas.....	52
10. Retrieve data.....	53
11. Troubleshooting.....	55
11.1 Startup problems.....	55
11.2. Error during operation.....	55
11.3. Error codes.....	56
11.4. Problems with updating software.....	59
11.5. Reset to factory defaults.....	59
11.6. GPS reception is weak or lost.....	60
11.7. Modem errors.....	60
12. Appendix.....	61
12.1. Specifications.....	61
12.2. IO port pin settings.....	62
12.3. CE Declaration of Conformity.....	63
13. Support.....	64

## 1. BibTag Timing system

BibTag is a timing concept for sports where simple setup, plus minimal race handling are needed. The BibTag system is portable and is designed for battery operation during outdoor sports events.

The standard BibTag system consists of the following components:

<p>Portable BibTag decoder (housed in a sturdy Pelican case)</p>	
<p>8 x antenna mats</p>	
<p>8 x antenna cables - in varying lengths up to 9m (30ft)</p>	
<p>Power cable (100 to 240 VAC) - 1.5 meter (5ft)</p>	

Modem/GPS unit with metal plate.



An alternative 4-mat BibTag system is also available with a set of 4 antenna cables and a decoder with 4 antenna connectors.

The battery capacity of an 4-mat BibTag System is 10 hours. An 8-mat BibTag System is 4 hours.

The following components can be ordered from MYLAPS as options for further expanding the BibTag system

Product:	Product code:	
BibTag Cable set	4 meter – 40S214 8 meter – 40S215	
12 VDC battery cable with clamps	40S091	
BibTag detection mat	30S032	
BibTag Start button	40R316	
BibTag Side Antenna	30S038	
BibTag Side Antenna cable	40S420	

BibTag USB Data cable (modem port>usb)	40S113	
BibTag USB reader	40S115	
BibTag antenna tester	40S112	
BibTag Network kit	40S116	
BibTag Raincover	40S007	

Additionally, you can purchase the following component from local suppliers:

- SIM card (this depends on your country and GSM cellular provider)
- Poweradaptors

## 2. Specifications BibTag System

### 2.1 BibTag Decoder

1.	Upper cover	Hinged upper cover (must be closed during a race to protect decoder from rain)	
2.	Modem/GPS Unit	Modem/GPS unit stored in the cover	
3.	Decoder panel	For connecting external devices and operator control	
4.	LED Status display	Shows battery, error and detect status	

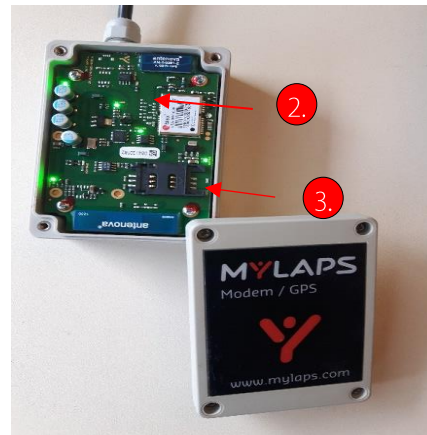
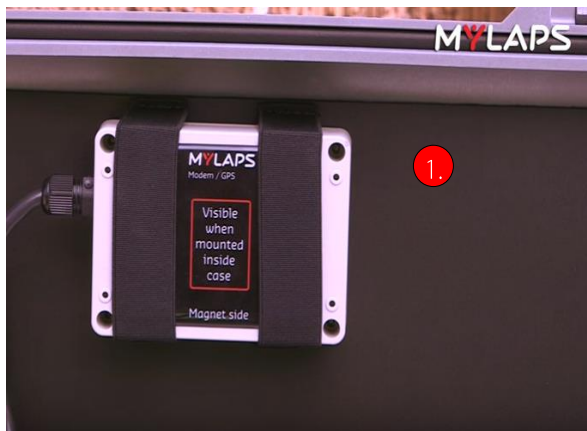

### 2.2. Modem/GPS Unit

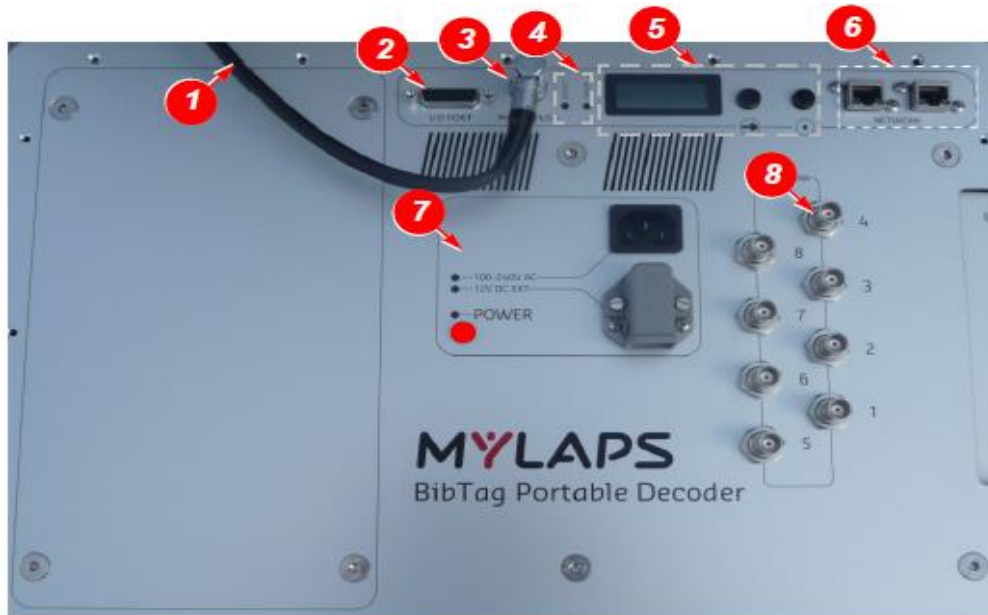

1.	Modem with attached cable and magnet field
2.	Print board with card holder - inside the modem
3.	Sim card holder - inside the modem

### 2.3.Decoder Panel



1.	Modem/GPS Cable	Cable from the Modem/GPS unit (normally stored in cover)
2.	I/O Port	For connecting external devices (Start gun, Start button, etc.)
3.	Modem/GPS connector	Connect the Modem/GPS unit
4.	Detect and error LED's	Detect LED flashes each time a BibTag passes over a connected antenna mat. Error LED flashes if an error is present
5.	Operator controls	2 buttons (scroll  and select  ) and display for menu selections and status
6.	Network connectors	To connect an ethernet cable for a wired connection to a laptop or network.
7.	Power connectors and "power on" button	AC Port for electrical power, connector for external power source (100-240 VAC or 12 VDC) here if required. Press the Power button to start the unit (the LED lights when power is on)
8.	Antenna connectors	Connect all the antenna cables (1 to 8) that are fed from the detection mats. A 4-antenna system is available with only 4 connectors



#### CAUTION - Damage

Danger of short circuiting decoder electrics. Always take special care that no water enters an opened decoder case as the connections are not completely waterproof and water may damage the internal electric circuitry. Never open the decoder case in damp conditions.



## 2.4.LED Status Panel



1.	Battery level indicators (E = empty; F = full)	The battery level indicator LEDs light up from left to right as the Decoder is charging with the following color definitions: - red = 0-20% full - yellow = 20-40% full - 1st green = 40-60% full - 2nd green = 60-80% full - 3rd green = 80-100% full
2.	Power indicator	Lights turn blue if the system is powered up.
3.	Bib detection indicator	Flashes each time a BibTag passes over a connected antenna mat
4.	Error indicator	Flashes if an error is present. Only red when something is wrong

Normally the internal battery (when fully charged) is sufficient for a race duration (maximum 6 hour for 8 mat systems; maximum 10 hour for 4 mat systems), however for longer races a 12 VDC external battery can be connected as follows:

### CAUTION - Equipment Damage

The BibTag will be seriously damaged if connected to an incompatible power supply. Only connect the BibTag to a 12 VDC external batter.

### Connect battery

<ul style="list-style-type: none"> <li>• Attach leads to battery terminals (red to +; black to -)</li> <li>• Insert the battery connector into the socket on the BibTag panel and check the LED is lit</li> <li>• Battery cable is optional item; not standard delivered with the system</li> </ul>	
---	--

### Check the connection

<ul style="list-style-type: none"> <li>• Switch power on (if not already on)</li> <li>• Press the button to access the 'Info' selections</li> <li>• Choose 'Battery info' for the battery information screen</li> <li>• Ensure that the external battery symbol is showing, and the battery has sufficient charge (more than 20%)</li> </ul>	
--	--



## 2.5. Antenna Mats



1.	Interlocking mat part	To connect the mats.
2.	Flap	To protect the antenna cables.
3.		Antenna cables are connected to the antenna in the center of the mat and fed along these grooves to the next mat or decoder.



### CAUTION - Equipment Damage

The antenna cable connections in the BibTag mats are not completely waterproof if the mats are completely submerged in snow or water. Never place the mats in a low lying area where water and snow can enter under the flap and possibly short circuit the antenna connectors.

## 2.6. Antenna Cables

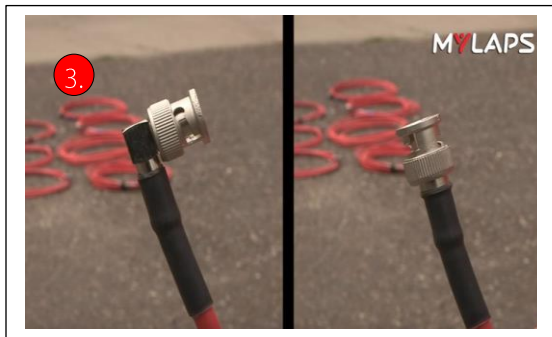

1.	Antenna cable set – 8 cables	From 1 to 8 meter
2.	Number tag	This number identifies the cable (from 1 to 8) to help when connecting the correct mat to the correct decoder connector
3.	Connectors	1 right angle and 1 straight shape connector. The right angle connector connects to the connectors of the decoder and the straight end connects to the mat.



### CAUTION - Equipment Damage

Never use MYLAPS Portable Decoder antenna cables on a MYLAPS BibTag system.

These are two different systems and are not compatible.

Never short circuit the MYLAPS BibTag decoder by attaching both ends of an antenna cable to the decoder.

## 3. The athletes

### 3.1. BibTag/Thin Tag

Athletes need a BibTag, so the system can detect their passings. A BibTag number is connected to the name of the athlete, after the event the results per athlete can be shown.



The BibTag and ThinTag have the same use, but in this text only the BibTag is mentioned. ThinTag is a thinner, lighter version of the BibTag. For Thin Tag, the same instructions as for the BibTag apply.

MYLAPS BibTags are the world's only sports timing tag that require only one tag attached to the Bib. BibTags are easy to use, for athletes and race organizers.

The BibTag is attached to the back of the runners Bib number and sends out a unique signal.

The all-weather BibTag will be activated by the antenna to send a signal to the BibTag Decoder.

On the back of the race number is the BibTag, this foam spacer contains the timing chip.

When used in a race, the BibTag must be worn correctly for the best detection and the following recommendations for race participants:

- Always keep the BibTag visible; do not remove or cover with a jacket
- Do not excessively bend or twist the BibTag
- Do not attach beside or under a zip: metal has a negative impact on the BibTag.
- Do not wear on your back or side, or around your arm or leg
- Do not cover the BibTag with your hand or arm when crossing the finish line: runners often do this when checking their watch when crossing the line
- Mats can become slippery when wet.
- Always remember that the mat must 'see' the BibTag number when you cross the finish line
- Do not separate the BibTag from the start number

#### NOTE:

Race organizers can post clear instructions at the 'Start' location for correct BibTag use.

Before use, each BibTag can be checked by passing it over a connected antenna to see it is detected and registered by the decoder (signalled by detection light and/or beep). Always reject any defective chips.

### 3.2. Multi Sports Tag



#### Disposable and reusable MultiSports Tag

The MultiSports Tag is designed and optimized for triathlons and mud runs and works with the MYLAPS BibTag timing system. The tags can be worn under a wetsuit (max. 5 mm) results are guaranteed since they have 3 integrated timing tags.

These tags are owned by timers or events and handed out to athletes at an event. After each race they can be collected, washed, stored, and ultimately used again at the next event. The reusable tags feature the same benefits as the disposable MultiSports Tags, but are made from longer-lasting and easily cleanable materials.

Both MultiSports Tags consist of 100% soft material for optimal comfort, have 3 integrated tags and are worn as a bracelet around the ankle. They can be worn underneath a wetsuit without performance loss in detection rate and accuracy.

The **reusable** MultiSports Tag consists of a foam layer for optimal comfort, a start number for easy identification and a Velcro strap on the outside to secure the tag. The reusable MultiSports Tag can be used in chlorinated and salt water. After the race the tags have to be collected in order to be reused in another event. A customer specific logo, coloring or strap is not possible for this product. The reusable MultiSports Tag has an expected lifespan of 2 years or about 30 events. After each race they can be collected, washed, stored, and ultimately used again at the next event. The reusable tags feature the same benefits as the disposable MultiSports Tags, but are made from longer-lasting and easily cleanable materials.

The **disposable** MultiSports Tag consists of a foam strap with a Tyvek layer that has a start number printed on it. An adhesive strip at the end of the strap makes application easy. The disposable tag can be provided with color coded race categories. The disposable tag minimizes pre and post-race handling: participants can keep the tag as a souvenir.

## 4. How to set up a BibTag Timing System

### 4.1. General

Every participant in a MYLAPS timed event wears a registered BibTag/MultiSports Tag containing a chip. When the Tag comes in the vicinity of a detection mat, the Tag continuously starts sending out messages with its unique identification (ID). The antennas in the detection mat receive these ID messages and transfer them to the Decoder. The Decoder determines the BibTag time for each ID by calculating the received signal strength from that BibTag. This passing time is calculated to an accuracy of at least 0.5 seconds.

The BibTag system can operate with multiple (up until 8 matts) and mats, and is responsible for:

- Controlling the antennas in the mats
- Keeping accurate time (via a GPS signal or via an internal clock)
- Data collection and storage (chip codes and times)
- Record a gunshot start so that the equipment can use this same start time as the official time
- Passing data from the Decoders to a central results computer via internet (GSM) with MYLAPS servers, or directly via an ethernet link
- Synchronizing multiple Decoder times via GPS

#### NOTE:

The antenna field will stop detecting the Tag after a period of seconds if the tag remains within the antenna field (Time between same Chip). This means that the Tag may be assigned a false start time if it has already been detected within the antenna field previous to the start time. To prevent this, the tags detected within the antenna field at the official start time will all receive this official start time.

## 4.2. How and where to set up the BibTag Timing System

- Determine the best location for the decoder. Based on traffic flow, start and finish line structures and access to electrical power.
- Narrow the course if necessary to ensure all athletes pass over the mats.
- Wait for the road to close before set up, so heavy vehicles don't damage the antennas.

To obtain a 99.8% detection rate we advise you to use a main and backup system at the start and at the finish. If your track is larger and you want detection during the track, you can add two extra BibTag systems per extra detection point.

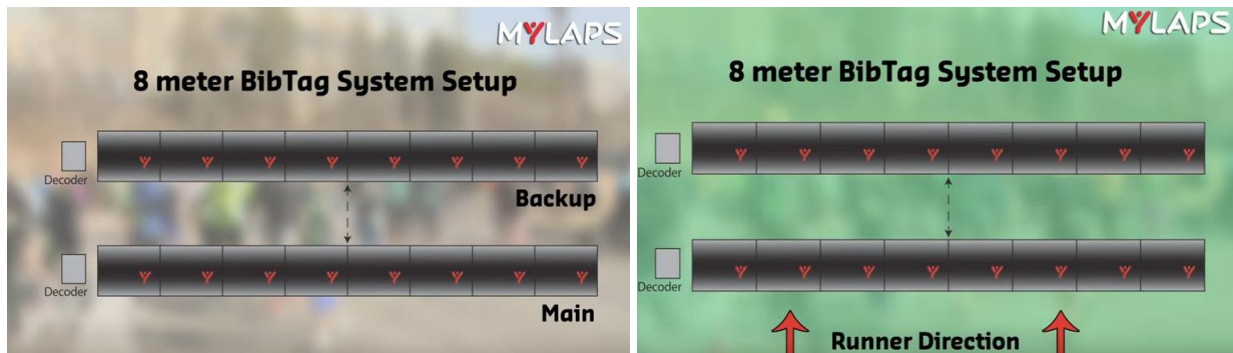

Set up your back up system in the same fashion, 3 meters apart to avoid interference and configure your decoders.



### 4.3. How to connect the mats and the cables

Lay the BibTag mats on the road and lock them together. The MYLAPS logo should face towards incoming runners, to prevent the runners kicking open the flap.

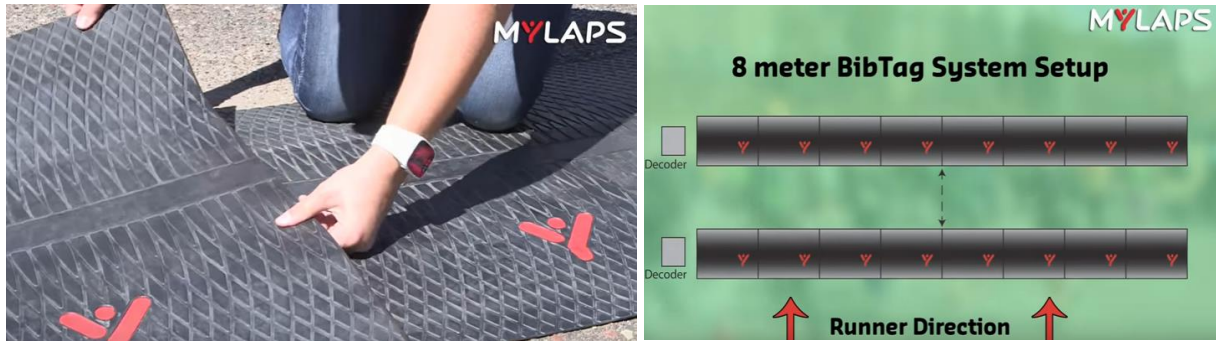

The BibTag cable set is numbered to match the antenna ports in the decoder and to indicate the length of the cable.



BNC connectors are on both ends of the cable. One end is right angle shaped and one end is straight. The right angle end connects to the decoder and the straight end connects to the mat.

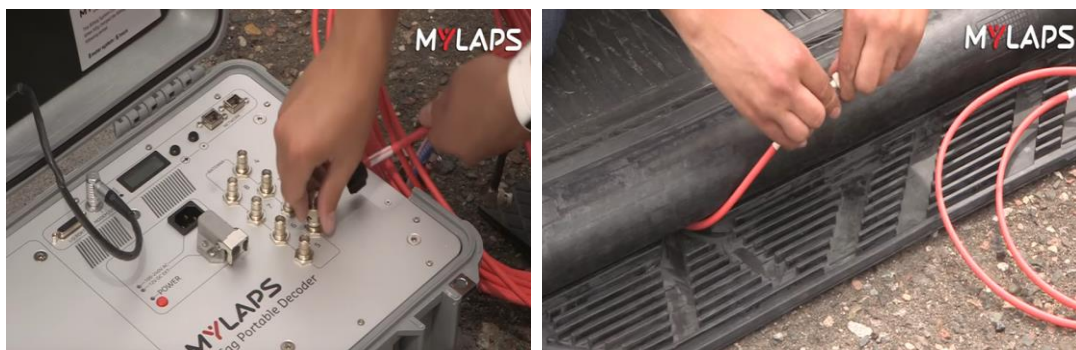

Connect all your mats by clicking them together.

Start with your largest cable, number 8, open the flap of the furthest BibTag mat. Make sure the cable within the mat is pointed to the decoder. Connect your cable and make sure the connection locks securely. Place the cable in the groove and feed it through the end. Move on to the next mat and repeat the process for each additional mat you are using. When you are done, close the flaps on the mats.

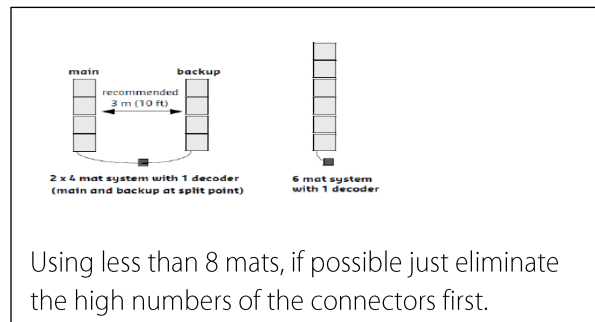

Using less than 8 mats, if possible just eliminate the high numbers of the connectors first.

Connect the right angle connectors to the decoders. The number on the cable must match with the same number on the antenna connectors on the decoder. Arranging the bundle of cables neatly, make sure you don't get kinks.



**Close case**

- Make sure that the antenna cables are all aligned in the cutout on the right side of the decoder case
- Carefully close lid (making sure no cables are trapped between cover and case)
- Close both front latches to make sure the case is properly closed so no dirt or moisture can enter



#### 4.4. Decoder initialization – no internet used

Open the case and take out the Modem/GPS and place outside the decoder, preferably higher for better signal reception. The decoder must be connected to the Modem.

Turn the decoder on, by pressing the power button. The power led and the lights in front of the case should go on



The BibTag internal clock is extremely accurate when recording timing data. It can be synchronized using time signals from GPS satellites. This guarantees precise time synchronization between multiple BibTag systems, and gives extreme accuracy over a long period. MYLAPS recommends to have the GPS connected at all times when operating the device. All date and time parameters are set via the menu selections on the control panel. See 4.3.1 Operator controls for more information.

**NOTE: Never change the time during a race. When the BibTag Decoder is powered down, the clock will no longer be accurate.** After the decoder has started up (this can take a while), the LCD screen should be read "GPS Locked". Click on the select button to synchronize your decoder to GPS.





- Press the scroll button →
- Scroll to "time line set up" and click on the select button.
- Go to "profile" and click on the select button ○.
- If this is the first system the runner will encounter - set the "profile" to "main"  
The system which is closest to the start line, will be set to "main".
- If this is the second system the runner will encounter - set the "profile" to "backup"
- Never set the "profile" to "scanner or expo" during the race.
- Press the scroll button
- Scroll to "time line set up" and click on the select button.
- Scroll to "number of antennas" and press select.
- Verify the number in the screen match with the number of mats connected to the decoder.
- Scroll to "time line set up" and click on the select button.
- Go to "Beep" and choose the beep type and the volume of the beep.
- The mats will detect the Tags and a beep and the led on the case will go on if a runner crosses the mat.
- The decoder will collect all passings (maximum of 94.000). When connected to MYLAPS Timing and scoring the personal results can be made.

#### 4.4.1. Decoder initialization – internet used – recommended

When you have the possibility to use internet, connect your decoder.

You can create live timing results and you can control the status of the decoder at any time.

<p>How to set up the decoder and connect it with internet?</p> <ul style="list-style-type: none"> <li>• Follow the steps as in 4.4.</li> <li>• Connect the decoder with internet, you can use ethernet or GSM connection.</li> <li>• Press the scroll button </li> <li>• Scroll to communication and click on the select button </li> <li>• Scroll to Server Communication and click on the select button</li> <li>• Choose between Ethernet or GSM and click on "accept"</li> <li>• You need to register your decoder online in Timing &amp; Scoring - see manual Timing &amp; Scoring</li> </ul>	
--	--

If you choose ethernet, connect an ethernet cable to the decoder and the network.

If you choose GSM, place a sim card in the modem/GPS unit. Open the modem/GPS Unit



## 4.5. Testing the signal

When you set up the total system, you can check the signal strength of the antennas. You can use a test Tag. Hold the tag on chest height and start of the furthest antenna and walk over all mats. The led on the suitcase will light up and a beep will sound.



On the LCD screen you will see the empty boxes be filled, which represents every antenna. The boxes will be filled temporarily when the Tag is detected in the field of the mat.

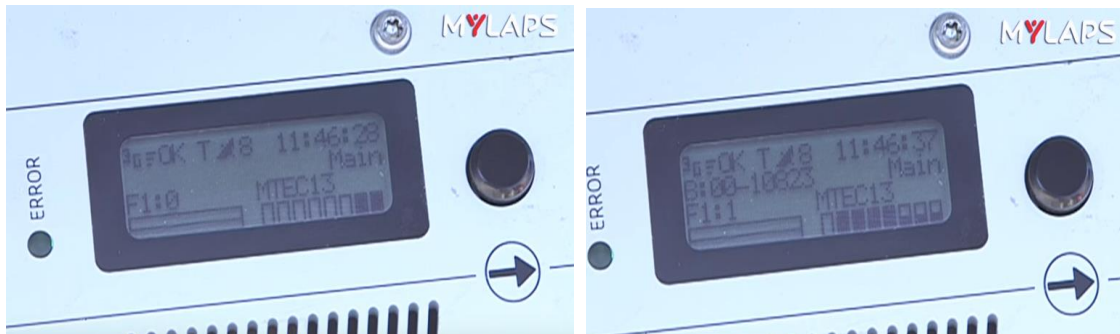

If a mat is not detecting the Tag, check the antenna cables and either replace them or the mat if necessary and repeat the test.

- Test BibTag by carrying a test BibTag across each of the antenna mats, in turn, and check:
- The BibTag is registered by the decoder (the detection LED is lit)
- The antenna symbols in the bottom of the screen show that the BibTag is detected by the individual antennas. As the BibTag is carried across a mat, the block symbol for that mat should show a full symbol. See example figure where BibTag is carried over the second mat.



Note: the block signal will "slowly empty" after a few seconds

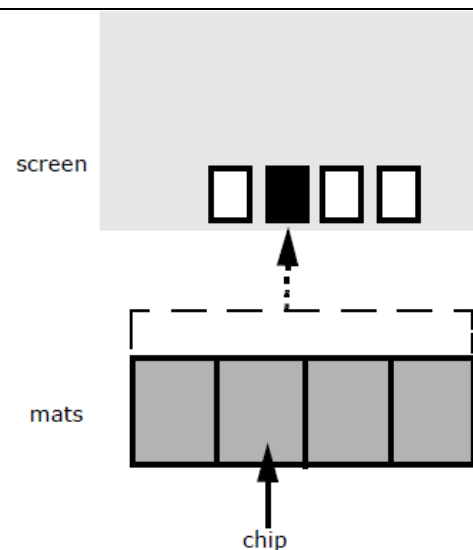

## 5. Clear and synchronize (sync)

### 5.1. Clear before sync your decoder – no internet necessary

#### Single event

After finishing your event, you connect your computer/laptop to the decoder. You connect the computer and the decoder with a network cable.

You open the program Timing & Scoring on your computer and the passing data of the event will be loaded from the decoder to Timing & Scoring. If you don't have an internet connection, you are only able to see passing data on your screen in Timing & Scoring. No live timing is possible.

After you loaded the passing data from the decoder to Timing & Scoring and saved the event file, you can clear your decoder.

<ul style="list-style-type: none"> <li>• Scroll → to "marker and files" click on the select button ○</li> <li>• Scroll to "clear device" select clear and click on the select button.</li> <li>• The passing data will be moved to a bin.</li> <li>• The passing data has not been synced with Timing &amp; Scoring</li> </ul>	 <p>The screenshot shows a monochrome LCD display with the following text: 'Marker', 'New File On Gun', a horizontal bar of dashes, 'Auxiliary', 'Clear device?', and a button labeled 'Clear'.</p>
--	--

#### Multiple Events

Sometimes you have multiple events during a short period, like in a weekend 3 events (Friday, Saturday and Sunday)

After every event you follow the steps like mentioned in a single event.

When you cleared the device, the passing data of the first event will be placed in a bin in the decoder. This will happen with second and third event as well.

The maximum amount of passings is 94.000 per decoder, this includes the passing data which have been placed in the bin.

### 5.2.Sync – internet is available

When you have an internet connection and connect the software Timing & Scoring all passing data will automatically load the passing data from the bin to Timing & Scoring and the capacity will be freed.

All your passing data will be cleared and there is no passing data left in the decoder.

We have a flexible pay per use model, called BiBTag Usage. BibTag Usage ensures, you will only pay for BibTags that are actually used during your events. With MYLAPS you don't have to worry about no-shows.

After you synced your decoder, an overview will be send to you by MYLAPS.

⚠️ Make sure that you synchronize your decoder within 5 days when you have more than 10.000 passings in the decoder. If you have more than 10.000 passings and you don't synchronize your decoder after 5 days, the passings on the next event will turn into the status "Expired".

⚠️ Passing data in the bin won't get automatically loaded to Timing & Scoring when live passings are coming in.

## 6. Removal and Storage

Retrieve race data (if not already done):

- Refer to Retrieve data (10) to see how to retrieve data (race results) from the decoder
- If no data connection to a Toolkit system is immediately available, data can be retrieved later (the decoder retains all data in memory even when power is off).

Switch off power

- Press 'Power' button
- Choose "YES" on menu by pressing button
- Pressing the 'Power' button for 7 seconds will also power down the system

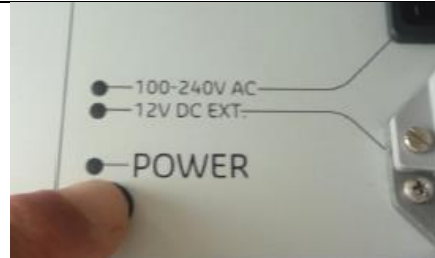

Disconnect cables

- Remove antenna cables from their connectors on case
- Remove power cable (if connected)
- Remove Ethernet cable (if connected)
- Remove starter pistol cable from I/O port (if connected)

Close case and move equipment

- Carefully close lid (making sure that nothing is trapped between cover)
- Close both front latches
- Move the BibTag equipment to a storage area or to an area where race data can be retrieved .



Store case in a dry area at storage temp of 0 °C to +40 °C (+32 °F to +104 °F), and close to a mains power socket

Charge Bibtag Decoder

- Attach 100 - 240 VAC power cable into AC connector on case
- Connect the power cable into the mains power socket
- Leave power connected until BibTag is next required (the battery will be automatically charged so it stays fully charged)



Disassemble antennas

- Carefully remove antennas from their slots in the antenna mats
- Loop the cables and load them into their carry bags
- Load all other cable accessories into their carry bags

Disassemble mats

- Carefully lift the mats one-by-one so that they separate from the adjacent mat

Store mats

- Make sure that the storage area used for the mats is flat with no sharp or protruding surfaces
- Never bend the mats and make sure the corners are not twisted under the mat
- Never lean the mats against a wall so that they are bent and deformed
- Always store the mats laid out flat with the MYLAPS logo facing up



CAUTION - Damage

Danger of damaging mats. Always store the mats according to the instructions given in the following step

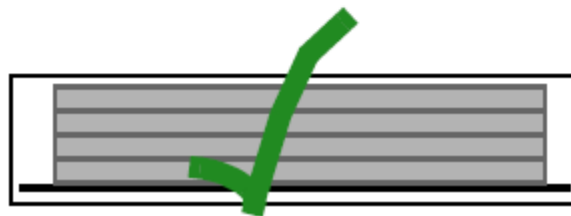
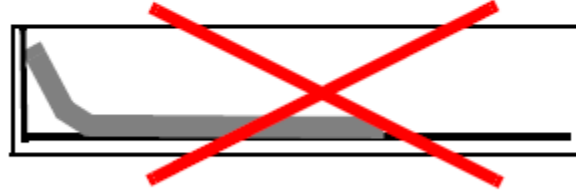
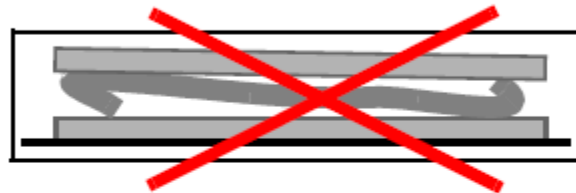
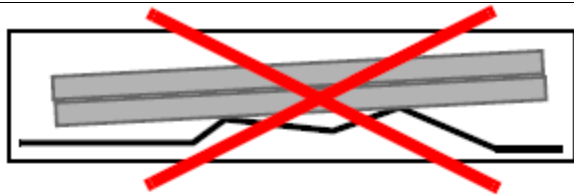

CAUTION - Damage

Danger of damaging cables. Always take special care when handling the antenna cables as they are easily damaged. Never excessively bend or twist them, and make sure the connectors are kept dry.



CAUTION - High voltage

Danger of electrocution. Before connecting power to the BibTag, make sure that all electrical connections are secure.



## 7. Operating the BibTag Decoder

### 7.1. Main Screen

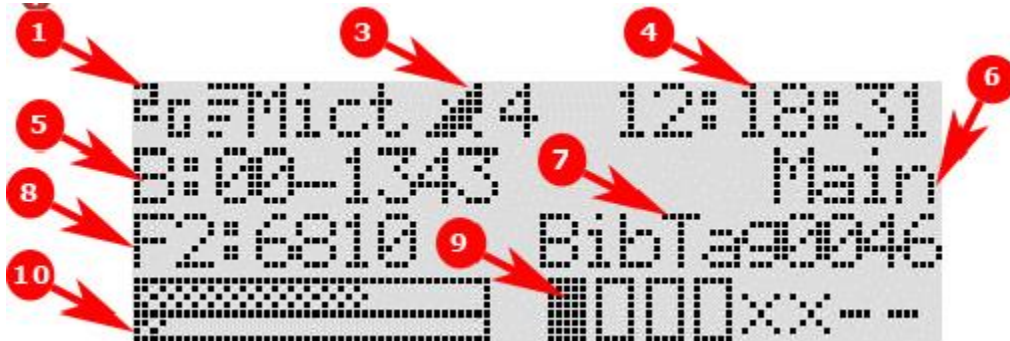

1.	Connection indication	<p>Can be NET, GSM or nothing (see Communication). Before and during initialization of the modem connection of the BibTag decoder to CCnet server the letters M, I, C, T are being displayed in the upper left area of the BibTag decoder display. These letters indicate the status of:</p> <p>M: BibTag decoder – BibTag modem connection          I: BibTag decoder - Internet connection          C: BibTag decoder - CCnet connection          T: BibTag decoder – Timing &amp; Scoring connection</p> <p>When the letter is shown in:          Lower case: The initialization or status is not OK          Upper case: The initialization or status is OK          Blinking between upper case and lower case: status is being updated</p> <p>2G icon means that 2G service is available on the GSM network (GSM/GPRS/EDGE).</p> <p>When there is an error the letters ER will be displayed as additional information. For more detailed information on possible error messages see Modem errors</p>
3.	Number of detected satellites	<p>The symbol indicates if GPS satellites are detected and how many. The symbol can change shape as follows:</p> <p>NC = not connected          Open symbol = satellite detected but no time available          Blinking symbol = waiting for a time to be assigned          Closed symbol = using GPS time          A clock symbol means that you can assign a manual time</p> <p><b>NOTE: 3 satellites is the minimum required number to sync GPS time.</b></p>

4.	Current time	Can be the time applied manually or the time assigned by the GPS connection
5.	Message	A short message indicating the last BibTag that has been detected or the current status (can be an error situation see 8.3 Errors during operation)
6.	Profile	Indicates the profile assigned to the decoder (Main, Backup or Scanner)
7.	Name of the decoder	Identifies the decoder
8.	File	Identifies the file number currently being used and the number of passings in the file.
9.	Antennas	The array of antenna mats currently installed to the decoder: Enabled and detected mats are shown as an open rectangle Mats activated by a chip are shown as a filled rectangle Enabled mats that are not detecting are shown as a blinking X Antenna connectors with no mat connections are shown as - Antenna connectors shown as a dashed rectangle cannot be detected (this also signifies the decoder is in scanner mode)
10.	Used memory	This double bar represents the capacity and the number of passings in the MYLAPS BibTag Decoder. The upper bar represents the first 10.000 passings. The lower bar represents the total memory (at least 90.000 passings). When in grey these are new and non-synchronized passings. When in black these are synchronized passings with MYLAPS.

 CAUTION

Make sure that you synchronize your decoder within 5 days when you have more than 10.000 passings in the decoder. If you have more than 10.000 passings and you don't synchronize your decoder after 5 days, the passings on the next event will turn into the status "Expired".

 CAUTION

The lower bar will start flashing after 75% of the total capacity (total capacity is at least ninety thousand) has been reached, to indicate you need to clear your BibTag decoder to prevent you from losing detections.

 NOTE



The backlighting for the screen will flicker if there is an error present.



## 8. Main Screen menu

### 8.1. Menus

From the Main screen, use the  and  buttons to navigate to the operator menu and info screens:

- Press  to show the menu options
- Press  to access the info screens



If the operator does not make a selection within a few seconds, the operator menu and info screens will automatically revert to the Main screen (exceptions are the Gun, Marker and Clock menu selections).



#### Content of the menus:

Markers and files	8.1.1.
Timeline setup	8.1.2.
General	8.1.3.
Communication	8.1.4.
Log	8.1.5.
Memory stick	8.1.6.
Info Screens	8.1.7.

In every paragraph we will explain the possibilities of the main screen menu.

Within the main menu, you find the various possibilities of the menus with their submenus

Once correctly setup, the BibTag system is ready to automatically record the chips as they pass the measuring point.

8.1.1. Markers and files	
Use the  and  buttons to navigate to the menu and submenus	
Menu	Submenu
• Create a new file	
• Gunshot	➤ New/exit
• Marker	➤ New/exit
• New file on gun	
• Clear device	
• Auxiliary	➤ Gun holdoff ➤ Ext. 1 holdoff ➤ Ext. 2 holdoff



Choose here to:

<ul style="list-style-type: none"> <li>• Create a new file</li> <li>• Set a gunshot or a marker</li> <li>• Clear the device memory</li> <li>• Use an Auxiliary menu to enter a delay time for the gunshot or marker device.</li> </ul>	
--	--

Create a new file:

<p>Choose Markers and files &gt; Create New File</p> <p>This function is useful for separating the detected chips times into individual files (e.g. it can be used to record multiple races after each other). A maximum 999 files can be created.</p>	
--	--

Gunshot:

<p>Choose Markers and Files &gt; Gunshot</p> <p>This function is useful for manually registering a start gun time at the beginning of a race.</p> <p>Choose 'New' to register a gunshot (choose 'Exit' to leave the screen without registering a gunshot).</p> <p>Attach the starting gun to the I/O port on the BibTag panel</p> <p>Never use the gun after the race has started, because all new BibTag passings will be adjusted to the new gun times; always use the marker function during the race to mark a Bib Tag – Marker</p>	 
---	--

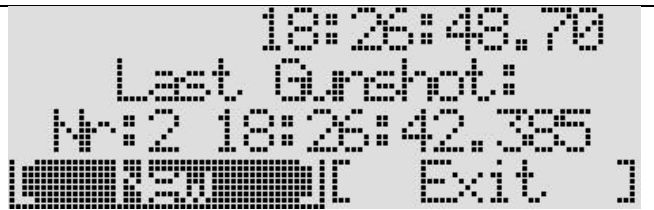
<p>See Auxiliary for information on how to set a delay for the gunshot.</p>	
---	--

**Marker:**

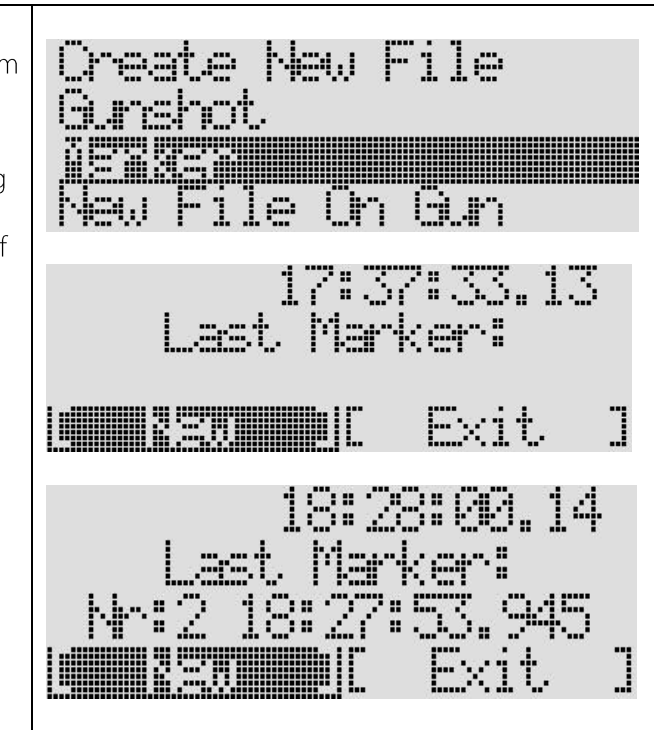
<ul style="list-style-type: none"> <li>• Choose Markers and Files &gt; Marker</li> <li>• Choose here to set a marker at a random point.</li> <li>• Choose 'New' to register a marker (choose 'Exit' to leave the screen without registering a marker).</li> <li>• A message appears showing the number of the marker and the time it was entered.</li> </ul>	
--	---





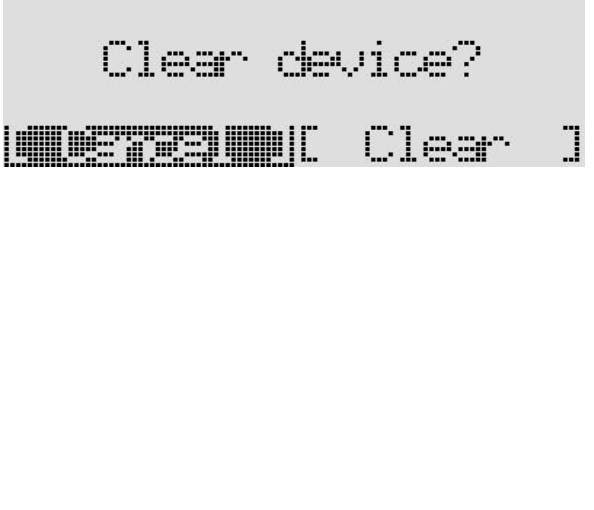

**New file on gun:**



<p>Choose Markers and Files &gt; New File on Gun Choose here "ON" when you want to create a new file with each gun shot.</p>	
--	--

### Clear device:

<p>Choose Markers and Files &gt; Clear device</p> <p>Here you can delete all passings (BibTags that have been detected), files and markers from the detector memory.</p> <p><b>Important: Make sure all recorded BibTag passings are synced before clearing.</b></p> <p>Confirm the delete action as follows:</p> <ul style="list-style-type: none"> <li>• Press to choose 'Clear' (choose 'Cancel' if you wish to cancel the selection).</li> <li>• Press to confirm the delete.</li> <li>• Wait until the message 'Clearing device...' disappears and you return to the main screen.</li> </ul>	 <p>The screenshot shows a monochrome LCD display with the text 'Clear device?' at the top. Below it, there are two options: 'Clear' and 'Cancel'. The 'Clear' option is highlighted with a white bar.</p>
---	--

### Auxiliary:





<p>Choose Create Marker and File &gt; Auxiliary</p> <p>Assign here the various hold off times (in milliseconds) for a start gun, or any other External device attached to the decoder I/O port. Navigate through the menu selections with  and choose a selection with .</p> <p>Once in the appropriate screen (see example of Gun holdoff below), change the assigned hold off time as follows:</p> <p>Use  and  to enter the required delay time and move to 'Accept'.</p> <p>Press  to accept and return to the main screen (choose 'Cancel' if you wish to cancel the selection).</p>	 <p>The screenshot shows a monochrome LCD display with the text 'Ext1 Holdoff' and 'Ext2 Holdoff'. Below these, there is a value '900 ms' and two options: 'Accept' and 'Cancel'. The 'Accept' option is highlighted with a white bar.</p>
--	---

8.1.2. Timeline set up	
Use the  and  buttons to navigate to the menu and submenus	
Menu	Submenu
<ul style="list-style-type: none"> <li>• Profile</li> </ul>	<ul style="list-style-type: none"> <li>➤ Main</li> <li>➤ Back up</li> <li>➤ Scanner</li> </ul>
<ul style="list-style-type: none"> <li>• Number of antennas</li> </ul>	
<ul style="list-style-type: none"> <li>• Reader channel</li> </ul>	<ul style="list-style-type: none"> <li>➤ Not for FCC/USA</li> </ul>
<ul style="list-style-type: none"> <li>• Beep</li> </ul>	<ul style="list-style-type: none"> <li>➤ Beep volume</li> <li>➤ Beep type</li> </ul>
<ul style="list-style-type: none"> <li>• Time between same chip</li> <li>• Continuous mode</li> </ul>	





Choose here to assign:

<ul style="list-style-type: none"> <li>• Profile</li> <li>• Number of antennas</li> <li>• Reader channel *</li> <li>• Beep</li> <li>• Time between same chip</li> <li>• Continuous mode</li> </ul> <p>* Reader channel is not available for USA/FCC systems</p>	
---	--







Profile:

<p>Choose Timeline &gt; Profile</p> <p>Here you can assign whether your decoder is used as a main or backup system, or as a scanner. Main and backup systems are set up in two rows at a recommended distance of 3m (10ft) from each other. Main and backup decoders are mostly used at start/finish lines to guarantee accuracy and ensure that all chip times are registered.</p>	
<p>A scanner assigned decoder can be used to check bibtags (never use this setting when the decoder is used in a race). The first array of mats that is passed is normally assigned as 'main' and the second array is assigned as backup. The backup system has less precise timing but is more sensitive for weak chip signals.</p>	
<p>Change the selection as follows:</p> <ul style="list-style-type: none"> <li>• Press  to choose the required setting (Main, Backup or Scanner).</li> <li>• Press  to move to the next field.</li> <li>• Press  to confirm and return to the main screen (choose 'Cancel' if you wish to cancel the selection).</li> </ul>	

### Number of antennas:

<p>Choose Timeline &gt; Number of antennas</p> <p>Assign here the number of antennas connected to your decoder (1 to 8).</p> <p>NOTE: A 4-meter system with a maximum 4 antennas is also available.</p>	
<p>Change the Number of Antennas as follows:</p> <ul style="list-style-type: none"> <li>• Press  repeatedly to increase the number of antennas until the correct number is shown.</li> <li>• Press  to move to the next field.</li> <li>• Press  to accept and return to the main screen (choose 'Cancel' if you wish to cancel the selection).</li> </ul>	

### Reader channel:

<p>Choose Timeline &gt; Reader Channel *</p> <p>Assign here the channel used by the reader to gather data. Always assign a different channel to a main and backup system to eliminate interference between decoders in close proximity. Also always assign a different channel to each of the 2 readers installed in an 8 antenna system.</p>	 <p>* This setting only applies to EU, Chinese and Japan BibTag systems</p>
<p>Change the Reader Channel as follows:</p> <ul style="list-style-type: none"> <li>• Press  repeatedly to assign the required symbol to the blinking field.</li> <li>• Press  to confirm the symbol and move to the next field.</li> <li>• Press  repeatedly to assign the required symbol.</li> <li>• Press  to move to the next field.</li> <li>• Press  to confirm and return to the main screen (choose 'Cancel' if you wish to cancel the selection).</li> </ul>	

### Beep:



<p>Choose General &gt; Beep</p> <p>Here you can set the decoder beeper volume (High/Medium/Low/Off) and the beeper type (Single/Continuous). Do this as follows:</p> <ul style="list-style-type: none"> <li>• Press <input type="radio"/> to select the beeper volume or type you want to have.</li> <li>• Press <input type="right"/> to move to the next field.</li> <li>• Press <input type="radio"/> to accept and return to the main screen (choose 'Cancel' if you wish to cancel the selection).</li> </ul>	
<p><b>Continuous mode:</b> As long as a tag is in the detection field of the decoder it will beep continuously. The decoder only generates 1 passing at the start of the beep, although the decoder beeps continuously, no more passings are generated.</p> <p><b>Single beep mode:</b> In single mode, the decoder beeps for one brief moment per generated passing. This allows the user to distinguish individual passings even when a tag (athlete) remains in the field of detection. E.a. 5 athletes passing the mats results in 5 short beeps.</p>	

### Time between same chip:

<p>Choose Timeline &gt; Time Betw. Same Chip</p> <p>This setting prevents a chip being accidentally and repeatedly registered while still in the vicinity of the antennas. If a chip is detected more than once within this interval, each new registration will be neglected until the interval is over.</p> <p>Change the time between the same chip as follows:</p> <ul style="list-style-type: none"> <li>• Press <input type="radio"/> to increase the number of milliseconds (default is 10; min is 3; max is 30).</li> <li>• Press <input type="right"/> to confirm the symbol and move to the next field 'Accept'.</li> <li>• Press <input type="radio"/> to confirm and return to the main screen (choose 'Cancel' if you wish to cancel the selection).</li> </ul>
--

### Continuous mode:





<p>Choose Timeline &gt; Continuous mode</p> <p>When continuous mode is set to ON, the decoder will create passings for a tag continuously, as long as a tag is in the detection field.</p> <p>The time Between Same Chip setting determines the time between the subsequent detections. When it is set to OFF, the decoder will create only one passing during the time a tag remains in the detection field.</p>	
---	--

8.1.3. General	
Use the  and  buttons to navigate to the menu and submenus	
Menu	Submenu
<ul style="list-style-type: none"> <li>• Clock</li> </ul>	<ul style="list-style-type: none"> <li>➤ Source</li> <li>➤ Date</li> <li>➤ Time</li> <li>➤ Time zone</li> <li>➤ Daylight saving</li> </ul>
<ul style="list-style-type: none"> <li>• Contrast</li> <li>• Name</li> <li>• Index</li> <li>• Factory defaults</li> </ul>	
<ul style="list-style-type: none"> <li>• Firmware</li> </ul>	<ul style="list-style-type: none"> <li>➤ Decoder</li> <li>➤ Reader module</li> <li>➤ Charger module</li> </ul>
<ul style="list-style-type: none"> <li>• Maintenance</li> </ul>	

Choose her to assign:



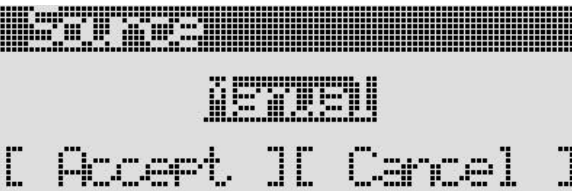

<ul style="list-style-type: none"> <li>• Clock</li> <li>• Contrast</li> <li>• Name</li> <li>• Index</li> <li>• Factory defaults</li> <li>• Firmware</li> <li>• Maintenance</li> </ul>	
---	---

Clock:







<p>Choose General &gt; Clock</p> <p>Here you can set the source (GPS or manual), date, time, time zone, and daylight saving for the decoder.</p> <p><b>IMPORTANT: Never change 'Clock' parameters during a race</b></p> <ul style="list-style-type: none"> <li>• Press  to select 'Manual' or 'GPS' depending on how you wish to assign your clock settings.</li> <li>• Press  to enter the setting and move to 'Accept'.</li> <li>• Press  to accept and return to the main screen (choose 'Cancel' if you wish to cancel the selection).</li> </ul>	 
--	--







Date:

<ul style="list-style-type: none"> <li>• Press  to select 'Date'.</li> <li>• Press  and  to enter the correct date and move to 'Accept'.</li> <li>• Press  to accept and return to the main screen (choose 'Cancel' if you wish to cancel the selection).</li> </ul>	
--	--





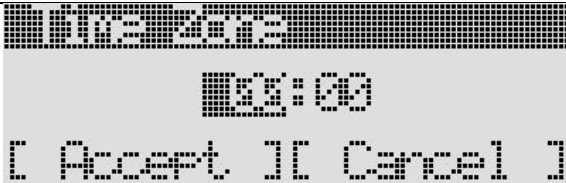

Time:

<ul style="list-style-type: none"> <li>• Press  and  to select 'Time'.</li> <li>• Press  and  to enter the correct time and move to 'Accept'.</li> <li>• Press  to accept and return to the main screen (choose 'Cancel' if you wish to cancel the selection).</li> </ul>	
--	--





Time zone:

<ul style="list-style-type: none"> <li>• Press  and  to select 'Time Zone'.</li> <li>• Press  and  to enter the correct time zone and move to 'Accept'.</li> <li>• Press  to accept and return to the main screen (choose 'Cancel' if you wish to cancel the selection).</li> </ul>	
--	---



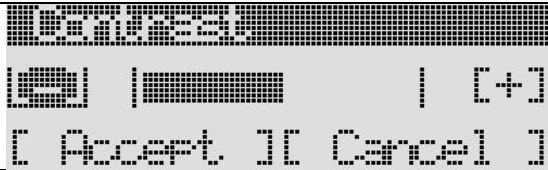

Daylight saving:

<ul style="list-style-type: none"> <li>• Press  and  to select 'Daylight Saving'.</li> <li>• Press  and  to choose between 'off' and 'on', and move to 'Accept'.</li> <li>• Press  to accept and return to the main screen (choose 'Cancel' if you wish to cancel the selection).</li> </ul>	
---	--







### Contrast:

<p>Choose General &gt; Contrast</p> <p>Here you can alter the contrast of the BibTag operator screen.</p>	
<p>Do this as follows:</p> <ul style="list-style-type: none"> <li>• Select [-] and press  repeatedly to dim the screen.</li> <li>• Select [+] and press  repeatedly to brighten the screen.</li> <li>• Press  to move to the 'Accept' field.</li> <li>• Press  to accept and return to the main screen (choose 'Cancel' if you wish to cancel the selection).</li> </ul>	



### Name:

<p>Choose General &gt; Name</p> <p>Here you can assign a personalized name for easy identification when the BibTag is connected to a network. This name will be displayed on the main screen, and in the MYLAPS software.</p>	
<p>Change the name as follows:</p> <ul style="list-style-type: none"> <li>• Press  repeatedly to assign the required symbol (alphabetic or numeric) to the blinking field.</li> <li>• Press  to move to the next field.</li> <li>• Repeat steps 1 and 2 until the name is correct.</li> <li>• Press  until 'Reset' is selected and press  to confirm and return to the main screen.</li> </ul>	





### Index:

<p>Choose General &gt; Index</p> <p>Here you can assign an index (maximum 2 characters) for the BibTag to identify the decoder in software. In Toolkit it is called device number.</p>	
<p>Change the index as follows:</p> <ul style="list-style-type: none"> <li>• Press  repeatedly to assign the required symbol (alphabetic or numeric) to the blinking field.</li> <li>• Press  to move to the next field.</li> <li>• Press  repeatedly to assign the required symbol (alphabetic or numeric).</li> <li>• Press  to move to the 'Accept' field.</li> <li>• Press  to confirm and return to the main screen (choose 'Cancel' if you wish to cancel the selection).</li> </ul>	





### Factory defaults:

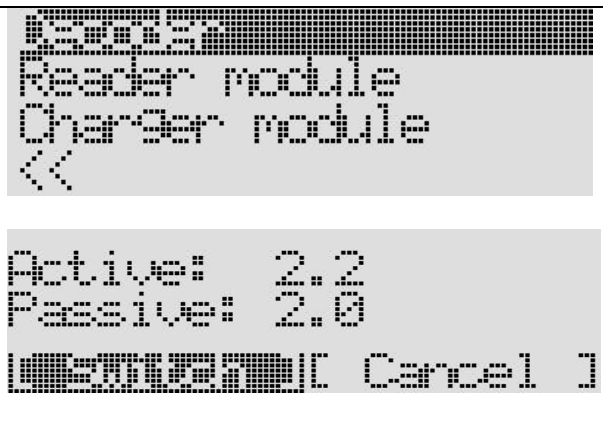

<p>Choose General &gt; Factory defaults</p> <p>Here you can reset all the software settings in the decoder to their default factory settings.</p>	
<p>Confirm the reset action as follows:</p> <ul style="list-style-type: none"> <li>• Press  to choose 'Default' (choose 'Cancel' if you wish to cancel the selection).</li> <li>• Press  to confirm the reset.</li> </ul>	

### Firmware:

<p>Choose General &gt; Firmware</p> <p>Here you can switch the current software version (to a previous version) and view the Reader and Charger module. View modules by pressing  and then .</p> <p>Switch software version as follows:</p> <ul style="list-style-type: none"> <li>• Press  to choose 'Decoder'.</li> <li>• Press  to choose 'Switch' (choose 'Cancel' if you wish to cancel the selection).</li> <li>• Press  to switch the software versions.</li> </ul>	
---	---

### Maintenance:





<p>Choose General &gt; Maintenance</p> <p>This function is only to be used by a MYLAPS service engineer, or after contact with MYLAPS.</p>	
<p>Enter the maintenance code as follows:</p> <ul style="list-style-type: none"> <li>• Press  repeatedly to assign the required character (alphabetic or numeric) to the blinking field.</li> <li>• Press  to move to the next field.</li> <li>• Repeat steps 1 and 2 to enter all four characters for the required code.</li> <li>• Press  to accept the address (choose 'Cancel' if you wish to cancel the selection).</li> </ul>	

8.1.4. Communication	
Use the  and  buttons to navigate to the menu and submenus	
Menu	Submenu
<ul style="list-style-type: none"> <li>• Server Communication</li> </ul>	<ul style="list-style-type: none"> <li>➤ Ethernet</li> <li>➤ GSM</li> <li>➤ Off</li> </ul>
<ul style="list-style-type: none"> <li>• Server location</li> </ul>	
<ul style="list-style-type: none"> <li>• Network</li> </ul>	<ul style="list-style-type: none"> <li>➤ Automatic</li> <li>➤ IP address</li> <li>➤ Subnet mask</li> <li>➤ Gateway</li> <li>➤ Primary DNS</li> <li>➤ Secondary DNS</li> </ul>
<ul style="list-style-type: none"> <li>• GSM Settings</li> </ul>	<ul style="list-style-type: none"> <li>➤ APN</li> <li>➤ User name</li> <li>➤ password</li> </ul>

Choose here to assign:

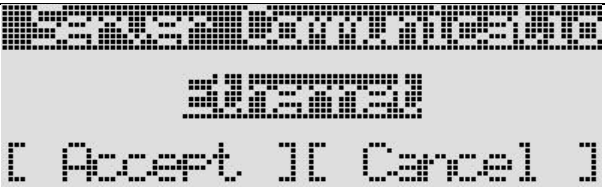
<ul style="list-style-type: none"> <li>• Server communication</li> <li>• Server location</li> <li>• Network</li> <li>• GSM Settings</li> </ul>	
<p>When setting up BibTag for the first time, register your decoder at the CCNet server - refer to <a href="http://partners.mylaps.com">http://partners.mylaps.com</a> for more information.</p>	



**Server communication:**

<p>Choose Communication &gt; Server Communication Here you can assign the method (Ethernet, GSM or off) for connecting to a server. "Off" means that communication to Toolkit is via LAN Ethernet or GSM means that communication to Timing &amp; Scoring is via WAN (using the MYLAPS server as intermediate)</p>	
<p>Make a selection as follows:</p> <ul style="list-style-type: none"> <li>• Press  to select 'Ethernet', 'GSM' or 'off'.</li> <li>• Press  to move to 'Accept'.</li> <li>• Press  to accept and return to the main screen (choose 'Cancel' if you wish to cancel the selection).</li> </ul>	

**Server location:**

<p>Choose Communication &gt; Server location Here you can enter a server address for the 'CCNetServer' for your region.</p>	
---	--

**Network:**

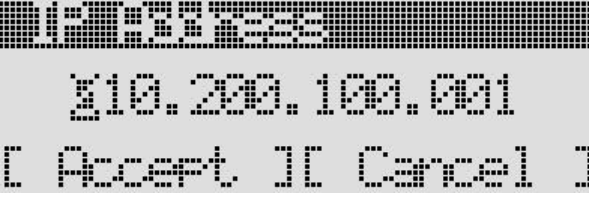
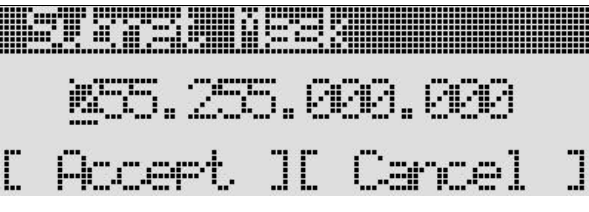
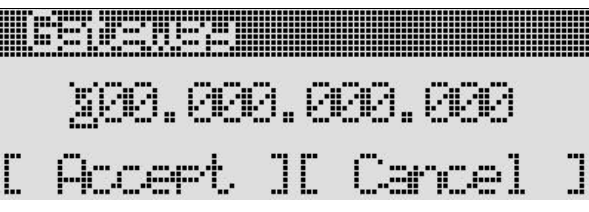
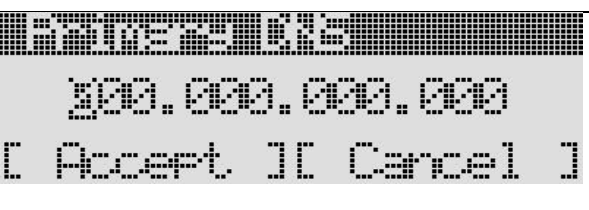
<p>Here you can assign all the specifications for the network connection. Choose 'Automatic' to ask the software to assign the address automatically (DCHP); alternatively you can manually set the IP address, Subnet mask and Gateway.</p>	
<p><b>Automatic</b> Choose 'on' for an automatic search for the network; set to 'off' before manually assigning IP address, etc.</p>	
<p><b>IP address</b> Always first set 'Automatic' to 'off' before you can assign fixed IP settings. The decoder cannot register IP addresses in the 198.51.100.x series.</p>	
<p><b>Subnet mask</b> Always first set 'Automatic' to 'off' before you can assign Subnet Mask settings.</p>	
<p><b>Gateway</b> Always first set 'Automatic' to 'off' before you can assign Gateway settings.</p>	
<p><b>Primary DNS</b> Always first set 'Automatic' to 'off' before you can assign DNS settings.</p>	

<p>Secondary DNS See 'Primary DNS'.</p>	
---	--





**GSM Settings:**

<p>Choose Communication &gt; GSM Settings</p> <p>Always first set 'Server Communication' to 'GSM' - see Server Communication.</p>	
---	--

Here you can configure the GSM (wireless modem) settings of the Modem/GSM unit. Settings must be obtained from your GSM provider and entered in the following screens:

- APN (Access Point Name)
- Username
- Password

Select APN:

- Press  repeatedly to assign the required character (alphabetic or numeric) to the blinking field.
- Press  to confirm the character and move to the next field.
- Repeat these steps to enter characters for the complete name (max. 20 characters)
- When the address is complete press  to move to the 'Accept' field.
- Press  to accept the address and return to the main screen (choose 'Cancel' if you wish to cancel the selection; choose 'CL' if you wish to clear the name).
- Repeat the same steps for 'Username' and 'Password'.

When setting up BibTag for the first time, register your decoder at the CCNet server.

### 8.1.5. Log

Use the  and  buttons to navigate to the menu and submenus

- Files
- Markers
- Errors

#### Log:

Here you can view the archive of Files, markers and errors.

#### Files:

Choose Log > Files

Choose 'Next' to view the next file.

```
File Nr: 1
Passings: 0
2013-02-18 17:39:14
XXXXXXXXXX Exit ]
```

#### Markers:

Choose Log > Markers

Choose 'Previous' to view previous marker.

```
Type: Gunshot Nr: 1
2013-02-18
18:08:09.196 1/1
XXXXXXXXXX Exit ]
```

#### Errors:

Choose Log > Errors

Choose 'First' to view first error. Choose 'Exit' to go out of the menu.

```
Error nr 510 1/11
Antenna 1 lost
Check antenna now!
XXXXXXXXXX Exit ]
```



### 8.1.6. Memory stick (only available when USB key inserted.)

Use the  and  buttons to navigate to the menu and submenus

When you insert an USB memory stick via the special adapter cable on the GPS/Modem connector of your BibTag decoder there will be an additional menu available: Memory Stick.



With this option you have the possibility to create a passing file that you can import into the MYLAPS Timing & Scoring software and/or to create support files should you encounter any issues with your BibTag decoder to send back to MYLAPS for further investigation.



When you select the "Write all passings" option the display will show the warning: "All passings will be charged for!"



Make sure your use a USB memory stick for at least 2 GB and FAT formatted.

This is to notify you that you will be using all the passings that are stored in the decoder and the buyer of these tags will be charged for the passings.

By clicking "Cancel" you stop the operation and no passings will be exported. When selecting "Export" you agree to be charged for all passings. The passings will be exported to the USB stick.\*

**\*Note: all passings that are charged already through Timing & Scoring will not be charged again.**

The file format of the passings file:

- Date-Time-SerialNr-Timeline.tag
- 20131127-170415-070046-Finish.tag means that it is the file of 27 Nov 2013 17h04:15, SerialNr: 07-00-46, Timeline: Finish

To import the passings file you will need to use Toolkit2 SP4 or higher.

### 8.1.7. Info Screens

From the Main screen, press the button repeatedly to navigate through the various info screens and eventually return to the main screen.

The following screens will be shown:

- Network
- EA/ Serial number
- Versions
- GPRS info
- Passings
- Battery info

#### Network

Choose  repeatedly until Network appears.  
Here you can read off the EA/Serial number of the decoder, the IP address for the connection to the decoder. Press  repeatedly to return to the main screen.

```

EA/Serial:
00-04-B7-07-01-70
IP: 192.168.10.40
Obtained: DHCP
    
```

#### Versions

Choose  repeatedly until Versions appears.  
Here you can read off the current BibTag software version installed in the decoder (and the previously installed 'passive' version, if present). Press  repeatedly to return to the main screen.

```

BibTag system
Active: 2.2
Expires in 21 days
    
```

#### GPRS Info

Choose  repeatedly until GPRS Info appears.  
Here you can read off the GPRS info by the decoder.  
Press  repeatedly to return to the main screen.

```

GPRS Info
Provider:
Server: server1.cha
Signal: 31
    
```



#### Passings

Choose  repeatedly until Passings appears. Here you can read off the number of passings (Bibtag detections) recorded by the decoder. Press  repeatedly to return to the main screen.

```

Passings
Stored: 4
Synced: 0
Credit left: 9996
    
```

## Battery info

Choose  repeatedly until Battery info appears. Here you can read off all the details about the internal battery (or external battery if connected). This information includes voltage, remaining charge and capacity. You can use the  button to scroll through the text. Press  to return to the main screen.



Internal Bat: 92%  
Volt: 16.23 V  
Left Cap: 37824mAh v

## 9. Maintenance

### 9.1. Introduction

Only qualified and trained personnel should perform maintenance on MYLAPS equipment. Maintenance can be described as, but not limited to:

- Checking and testing components
- Cleaning the unit and individual components - accumulated dirt can hamper unit operations
- Installing and removing parts from the unit
- Troubleshooting any malfunctions that may occur on the unit before, during and after operations
- Calibrating and adjusting settings on the unit.

### 9.2. Periodic maintenance schedules

Maintenance activity	monthly	6-monthly	As required
Clean		●	●
Charge battery	●		
Check/update software		●	
Calibrate battery indicators (3.2.4)		●	
Remove/replace SIM card			●
Replace battery			●
Replace cables and antennas			●

### 9.2.1. Clean

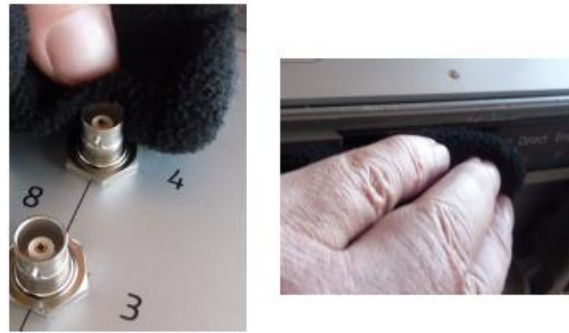

- Take a clean soft cloth and moisten it with clean water (do not use an abrasive cleaning liquid).
  - Using gentle strokes, clean the inside of the case, including the display screen and antenna connectors.
  - Dry off any excess moisture.
  - Use a newly moistened cloth to clean the outside of the case, including the front LED display.
- Use a moist cloth to clean the antenna cables, paying particular attention to remove any dirt in the connectors.
- Dispose of the cleaning materials (check your local environmental regulations).



#### CAUTION - Environmental hazard

Plastic and other waste products are harmful to the environment. Dispose of waste items in a responsible, environment-friendly manner. Separate recyclable products from other, non-recycle waste. Heed site regulations and obey local environmental by-laws.

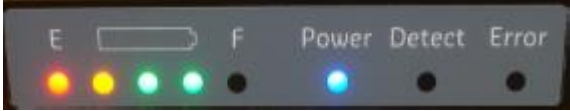

### 9.2.2. Charge battery

<p>Check that temperature of the charging location is within range 0-40 °C (+32 to +104 °F).</p>	
<p>Connect cable:</p> <ul style="list-style-type: none"> <li>• Switch off BibTag decoder at main switch (you can leave the power on, but charging will take longer)</li> <li>• Attach 100 - 240 VAC cable into AC connector on display panel</li> <li>• Connect the power cable into the main power socket.</li> </ul>	
<p>Check the battery status at the front of the case:</p> <ul style="list-style-type: none"> <li>• The LEDs will gradually light from left to right as charging is in progress (last LED will blink)</li> <li>• Wait until battery is fully charged and all 5 LEDs remain lit (takes 8 hours from empty to full when device is switched off).</li> </ul>	
<p>Remove power (optional): MYLAPS recommends leaving power connected to retain battery life and ensure the BibTag is fully charged and ready for its next use</p>	
<p> <b>CAUTION - High Voltage</b> Before connecting power to BibTag, make sure that all electrical connections are secure.</p>	

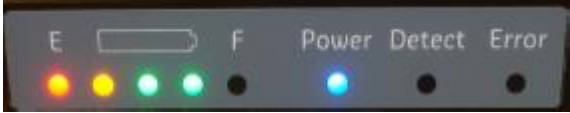

### 9.2.3. Check/Update software

- Connect to a local internet provider via a cable connection or via GSM
- Access the MYLAPS support website and check if there is updated decoder firmware
- Update version (if required):
  - Follow the instructions on the support website to download and install the updated firmware
- Check update:
  - Confirm reboot to new version
  - Verify that new version works correctly (if problems occur, refer to section Troubleshooting)



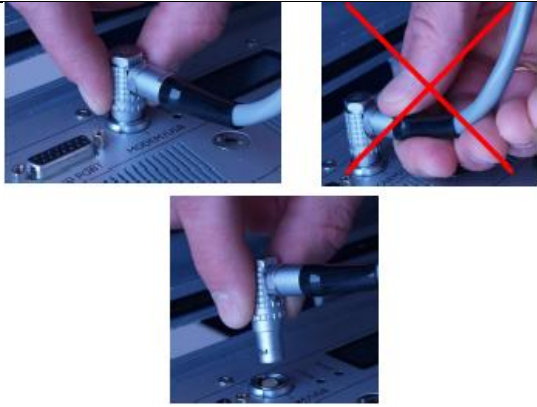

### 9.2.4. Calibrate battery indicators

<p>Check that temperature of the charging location is within range 0 to +40 °C (+32 to +104 °F).</p>	
<p>Fully charge the battery until the green 'F' lamp stays constantly lit (takes 8 hours from empty to fully charged when device is switched off).</p>	
<ul style="list-style-type: none"> <li>• Deplete battery:             <ul style="list-style-type: none"> <li>➤ Disconnect power from the Decoder</li> <li>➤ Switch on the Decoder</li> <li>➤ Leave the Decoder running until the internal battery is completely empty (can take 12 hours from full to empty)</li> <li>➤ The Decoder will switch off automatically to prevent battery damage.</li> </ul> </li> </ul>	
<p>Fully charge the battery until the green 'F' lamp stays constantly lit (takes 8 hours from empty to fully charged when device is switched off).</p>	
<p> <b>CAUTION - High Voltage</b> Before connecting power to the decoder, make sure that all electrical connections are secure.</p>	

### 9.2.5. Remove/Replace SIM card

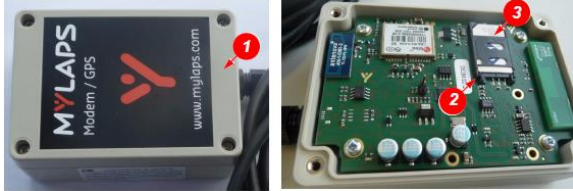
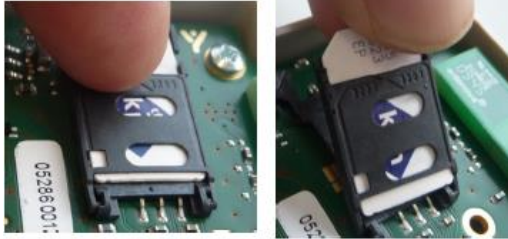
<p>Disconnect unit cable:</p> <ul style="list-style-type: none"> <li>• Place your fingers around the ribbed part of the connector (never disconnect it by pulling on the cable)</li> <li>• Press the connector with a vertical motion downwards</li> <li>• Remove the connector by pulling it with a smooth vertical motion upwards to unlock it.</li> </ul>	
<p>Remove unit:</p> <ul style="list-style-type: none"> <li>• Remove the unit from its attachment straps in the cover.</li> </ul>	

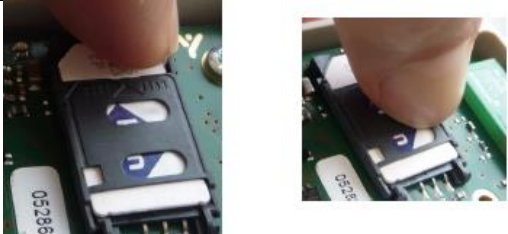

<p>Remove unit cover:</p> <ul style="list-style-type: none"> <li>• Unscrew the 4 corner screws with a screwdriver</li> <li>• Remove the cover to expose the card holder.</li> </ul>	
<p>Open card holder:</p> <ul style="list-style-type: none"> <li>• Slide down the front of the card holder slightly to release the holder</li> <li>• Flip the holder open to access the card</li> </ul>	
<p>Remove card:</p> <ul style="list-style-type: none"> <li>• Gently slide the old SIM card out of the holder</li> <li>• Leave the holder in its upright position</li> </ul>	
<p>Replace card:</p> <ul style="list-style-type: none"> <li>• Gently slide the new SIM card into the holder, making sure the cut-out corner is on the top left</li> <li>• Press the new card completely into place in the base of the holder.</li> </ul>	
<p>Close holder:</p> <ul style="list-style-type: none"> <li>• Press the holder down into its closed position, making sure that the card is not bent or damaged</li> <li>• Slide down the front of the card holder to lock the holder</li> </ul>	
<p>Replace unit cover:</p> <ul style="list-style-type: none"> <li>• Place the unit cover back on the unit</li> <li>• Firmly screw in the 4 corner screws</li> </ul>	

Replace unit:

- Replace the unit in its attachment straps in the decoder cover, making sure that the label on the base of the unit is visible
- Place your fingers around the ribbed part of the connector and press the connector with a vertical motion downwards into the connector (making sure it locks in place)

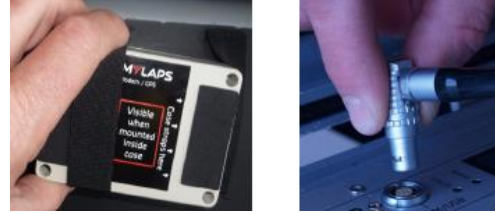

**CAUTION - Equipment damage**

To prevent damage to the SIM card and possible data loss, always disconnect the modem/GPS unit before removing/replacing the card. Always correctly connect and disconnect the modem/GPS cable. Only handle the cable connector by holding it on the ribbed part of the connector, never pull on the cable.

Also always take special care to prevent moisture entering the opened modem/GPS unit, and take standard precautions to prevent ESD when handling electrical components.

### 9.2.6. Replace battery

Please contact MYLAPS for the procedure for replacing the battery. The contact details can be found at the end of this manual.

### 9.2.7. Replace cables and antennas

Please contact MYLAPS for the part numbers and ordering instructions. The contact details can be found at the end of this manual.





## 10. Retrieve data

Here you can choose from the following data retrieval methods:



Use the  and  buttons to navigate to the menu and submenus

- Retrieving data (local network via Ethernet cable)
- Retrieving data (GSM)
- Retrieving data via internet (Ethernet)

### Retrieving data (local network via Ethernet cable)

<ol style="list-style-type: none"> <li>1. Connect an Ethernet cable <ul style="list-style-type: none"> <li>• Firmly click the cable into one of the two network connectors on the panel (always use a MYLAPS supplied Ethernet cable, or standard Ethernet UTP cable up to a max. 100m (300ft) long).</li> <li>• Check the orange LED on the network connection is on</li> </ul> </li> </ol>	
<ol style="list-style-type: none"> <li>2. Choose Communication &gt; Network <ul style="list-style-type: none"> <li>• From here you can select one of the following:</li> <li>• If you wish to automatically assign the network settings - go to step 3</li> <li>• If you wish to manually assign the network settings - go to step 4</li> </ul> </li> </ol>	
<ol style="list-style-type: none"> <li>3. Choose 'Automatic': <ul style="list-style-type: none"> <li>• Select 'on'</li> <li>• Select 'Accept'</li> <li>• Continue at step 5</li> </ul> </li> </ol>	
<ol style="list-style-type: none"> <li>4. Choose IP address: <ul style="list-style-type: none"> <li>• If 'AUTO' is on, a new screen will appear asking you to 'Disable AUTO first' - do this by selecting 'OK'</li> <li>• Once in the IP screen, use the operator buttons to enter the IP address and choose 'Accept'</li> <li>• Do the same to manually assign the 'Subnet mask', 'Gateway' and 'DNS' (Gateway and DNS are optional if an internet connection is not required or is not available)</li> <li>• Continue at step 5</li> </ul> </li> </ol>	
<ol style="list-style-type: none"> <li>5. When connected to the network, use MYLAPS software (e/g Timing &amp; /Scoring) to retrieve data.</li> </ol>	

### Retrieving data (GSM)

<p>Select internet mode:</p> <ul style="list-style-type: none"> <li>Choose menu 'Communication', then 'Server Communication'</li> <li>Use the operator buttons to toggle from 'Ethernet' to 'GSM' and then select 'Accept'</li> </ul>	
<p>Check GSM connection</p> <ul style="list-style-type: none"> <li>Return to the Main screen</li> <li>Check the left of the top line is showing an antenna symbol with vertical bars next to it.</li> <li>If this does not appear within a minute, refer to Troubleshooting</li> </ul>	
<p>When connected to the network, use MYLAPS software (e/g Timing &amp; /Scoring) to retrieve data.</p>	

### Retrieving data via internet (Ethernet)

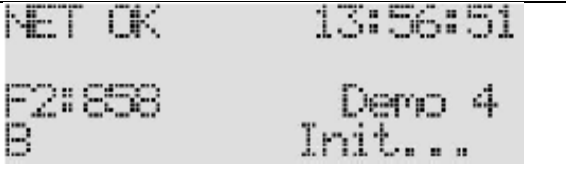
<p>Select internet mode:</p> <ul style="list-style-type: none"> <li>Choose menu 'Communication', then 'Server Communication'</li> <li>Choose 'Ethernet' to connect to the internet via your local server</li> </ul>	
<p>Check connection:</p> <ul style="list-style-type: none"> <li>Return to the Main screen</li> <li>Check that the top line is showing 'NET OK'</li> <li>If this does not appear within a minute, refer to 8 Troubleshooting</li> </ul>	
<p>When connected to the network, use MYLAPS software (e/g Timing &amp; /Scoring) to retrieve data.</p>	

## 11. Troubleshooting

Troubleshooting for the BibTag can be divided into 3 distinct categories:

- Startup problems
- Operating errors and warnings (signaled by screen messages)
- Problems with updating software
- Reset to factory defaults
- GPS reception is weak or lost
- Modem errors

If troubleshooting does not solve a problem, contact MYLAPS at [support@mylaps.com](mailto:support@mylaps.com). Alternatively, check the MYLAPS forum site for similar problems and solutions - see <http://partners.mylaps.com>.

### 11.1 Startup problems

Normally when starting up the BibTag decoder, the main screen will appear after the power button is pressed on the control panel. However, the following problems may be encountered during startup.

#### No power is available (no LEDs lit)

Connect power to the BibTag decoder and check if the 'E' battery indicator is lit:





If lit, charge the BibTag until the internal battery is sufficiently full (the second charge LED starts to blink)

If battery indicator is not lit, contact MYLAPS

#### Start screen freezes

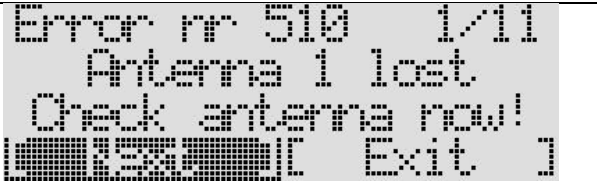
Restart (startup can take longer after a restart).

### 11.2. Error during operation

<p>If errors or warnings occur during operation, a flashing error message is displayed in the middle of the BibTag control screen. See location in following figure.</p>	
<p>The red 'error' LED on the panel on the front of the case (and beside the control screen) will also glow continuously for an error. To acknowledge the error and clear the message, press the  or  buttons. In an extreme emergency situation, hold in the main power switch for 7 seconds to completely shut down the BibTag.</p>	

### 11.3. Error codes

Errors can be caused by human, software, mechanical or electrical faults - read the message carefully, and decide upon the best course of action. The following table alphabetically lists the various operating errors as follows:

- Error text
- Possible Causes (in order of likelihood)
- Solutions to the listed causes (also in order of likelihood) with suggested procedure number (as listed in the Maintenance section of this manual)

ID	Error	Problems	Solutions
312	Ambient temperature too high to charge	Surrounding temperature too high to charge battery	Charge battery in correct temp. range
310	Ambient temperature too low to charge	Surrounding temperature too low to charge battery	Charge battery in correct temp. range
510	Antenna 1 lost Check antenna now	Antenna connection is faulty	Check the antenna connections
512	Antenna 2 lost Check antenna now	Antenna connection is faulty	Check the antenna connections
514	Antenna 3 lost Check antenna now	Antenna connection is faulty	Check the antenna connections
516	Antenna 4 lost Check antenna now	Antenna connection is faulty	Check the antenna connections
518	Antenna 5 lost Check antenna now	Antenna connection is faulty	Check the antenna connections
520	Antenna 6 lost Check antenna now	Antenna connection is faulty	Check the antenna connections
522	Antenna 7 lost Check antenna now	Antenna connection is faulty	Check the antenna connections
524	Antenna 8 lost Check antenna now	Antenna connection is faulty	Check the antenna connections
300	Battery error	Battery is not connected or has been shut down by temperature protection	Contact MYLAPS
302	Battery error	Warning that the battery charge level is becoming low	Connect to an external battery, or connect to AC power (if no other option)
330	Battery status Read failed	Software error	Restart

ID	Error	Problems	Solutions
332	Battery fuse broken	Battery fuse is faulty	Replace fuse
316	Battery temperature too high to charge	Battery temperature too high	Charge battery in correct temp. range
314	Battery temperature too low to charge	Battery temperature too low	Charge battery in correct temp. range
600	CCNet error Contact MYLAPS	Connection to the CCNet server is lost	Wait for BibTag to reconnect. If error occurs frequently, check GSM status or network connections
604	CCNet Unregistered Register device	Device is unregistered	Register the BibTag at the CCNet server - refer to <a href="http://partner.mylaps.com">http://partner.mylaps.com</a> for more information
602	CCNet Auth failed Login OK?	Internet unavailable	Check APN, User name and password. Contact network provider
	CCNet not found Server settings OK?	Internet unavailable	Check APN, User name and password. Contact network provider
328	Charge error high current	The measured charge current is too high	The measured charge current is too high
326	Charge error low current	The measured charge current is too low	Connect alternative (110 - 240 VAC) supply. Contact MYLAPS if error repeats
102	Chip queue at 75% save passings	Memory is becoming full	Save the current passings to Timing & Scoring
104	Chip queue at 90% save passings	Memory is becoming full	Save the current passings to Timing & Scoring
106	Credit time > 75%	Credit time is running out	Sync to Tag Use Server
108	Credit time expired	Credit time has run out	Sync to Tag Use Server
400	Communication error Contact MYLAPS	Undefined	Contact MYLAPS
500	Decoder error Contact MYLAPS	Internal communication failed	Contact MYLAPS



ID	Error	Problems	Solutions
804	Decoder time drift Check GPS unit	No GPS sync for very long time (more than 2days); Or internal clock drift too much	Connect GPS Contact MYLAPS
504	Decoder time failed Contact MYLAPS	Internal communication failed	Contact MYLAPS
502	Decoder not found Contact MYLAPS	Internal communication failed	Contact MYLAPS
506	Decoder conn lost Contact MYLAPS	Internal communication failed	Contact MYLAPS
	Decoder Re-read	Internal communication resync was required	Contact MYLAPS
304	EM Com error FE	Undefined	Contact MYLAPS
306	EM Com error OE	Undefined	Contact MYLAPS
308	EM Com error BRK	Undefined	Contact MYLAPS
336	External battery low	Warning that external battery charge level is low and BibTag will switch to internal battery supply.	Connect to an extra external battery, or connect to AC power (if no other option)
706	Firmware will expire in 1 month	Firmware must be updated	Install new firmware
708	Firmware expired Update now	Firmware must be updated	Install new
	GPS	No communication is possible via GPS - no sync with GPS time	Restart
334	Internal battery disconnected	Battery connection is disabled	Reconnect
320	Maintenance required battery voltage high	Battery has been charged at too high a current	Replace battery if message repeats
322	Maintenance required battery delta T	Battery has been loaded for too long	Replace battery if message repeats
324	Maintenance required battery capacity	Battery has been loaded for too long	Replace battery if message repeats
704	Old EM firmware Update firmware	Started wrong software version	Reload correct firmware

ID	Error	Problems	Solutions
702	Old reader firmware Update firmware	Started wrong software version	Reload correct firmware
318	Supply voltage load high	The measured supply current is too high	Connect alternative (110 - 240 VAC) supply. Contact MYLAPS if error repeats
200	Timing error Contact MYLAPS	Undefined	Contact MYLAPS
805	Unexpected time jump No GPS sync anymore	Unexpected time jump in GPS time occurred; Decoder is now running internal clock until reboot	Contact MYLAPS
508	Unsupported decoder Contact MYLAPS	Internal communication failed	Contact MYLAPS
700	Update error Contact MYLAPS	Software problem	Contact MYLAPS
	Version changed to Version x.x	Confirmation of a software update	Press operator button to acknowledge message.

#### 11.4. Problems with updating software

If a problem occurs with an updated software version, BibTag can revert to a working software version as follows.

- Check BibTag is started:
  - If BibTag does not start correctly, restart to force a reboot with a working software version
- Update software and make sure you select a software version that previously ran correctly on your BibTag.
- Report software problem to MYLAPS.

#### 11.5. Reset to factory defaults

If required, BibTag decoder can be reset to the original factory settings.

<ul style="list-style-type: none"> <li>• Access General &gt; Factory settings</li> <li>• Use the operator buttons to choose 'Default'</li> <li>• The controller will automatically reboot with the factory defaults.</li> </ul>	 <p>The image shows a monochrome LCD screen. The top two lines display the text "Set all settings to default?". Below this, a horizontal bar contains the word "Default" in a larger font, indicating the selected option.</p>
---	--

### 11.6. GPS reception is weak or lost

- Solve problems with a weak or lost GPS signal as follows.
- Reposition the Modem/GPS unit so that it has a clear view of any possible satellites (not obstructed by buildings, trees, etc.)
- Check signal strength
- Check the number of GPS satellites shown on the top of the screen (should be showing at least 3 satellites)
- Reposition the Modem/GPS unit again if necessary

### 11.7. Modem errors

When connection is set to GSM, the main screen can show the following error messages. Only one modem error will be active at the same time. In case of a connection issue, these indicators are being displayed at the location of the MICT indication in the upper left area of the display:

MDM!:	No GPRS modem connected to the BibTag decoder	Check the GPRS modem connection to the BibTag decoder
SIM!:	No SIM card has been detected by the GPRS modem	Check the SIM card in the GPRS modem
PIN!:	The SIM card is PIN locked	Unlock the SIM card using a mobile phone or USB modem
NET!:	No GPRS network	<ul style="list-style-type: none"> <li>• Relocate modem</li> <li>• Use other provider</li> </ul>
INI!:	GPRS service settings cannot be initialized	<ul style="list-style-type: none"> <li>• Check the GPRS modem APN settings</li> <li>• Check the CCnet server location settings</li> </ul>
APN!:	GPRS service cannot be established	Check the GPRS modem APN settings
SRV!:	GPRS service cannot be established	<ul style="list-style-type: none"> <li>• Check the GPRS modem APN settings</li> <li>• Check the CCnet server location settings</li> </ul>
CCN!:	BibTag decoder cannot connect to the CCnet server	Check the CCnet server location setting
DEV!:	BibTag decoder has not been registered on the CCnet server	Register your decoder to the CCnet server
ERR!:	Other error.	

## 12. Appendix

### 12.1. Specifications

#### Decoder

Material	Modified Pelican 1500 case
Dimensions (LxWxD)	47x35.7x17.6cm (18.5x14.06x 6.93inch)
Weight (including accessories)	16 kg (35 lb)
AC input voltage	100 to 240 VAC at 50/60 Hz
Power consumption (charging)	45 W
Typical power consumption (batt. operation)	30 W
Max. power consumption (mains operation)	40 W
Internal battery capacity	12 V / 17 Ah
Max. charge time (device switched off)	8 hours
Operating time (with full battery)	10hours (4mat system); 6hours (8mat system)
Operating temperature (charging)	0 to +40 °C (+32 to +104 °F)
Operating temperature (not charging)	-20 to +50 °C (-4 to +122 °F)
Storage temperature	0 to +40 °C (+32 to +104 °F)
Relative humidity	Max. 90%, non-condensing
Pollution degree	III
Protection class (cover closed)	IP54
Protection class (cover open)	IP33
Max. chip passing speed	40 km/h (25 mph)
Max. unique chip detects	50/sec
Timing Resolution	0.001 sec
Clock tolerance	1 ppm
Maximum detection buffer size	80,000 chips
Life span	approx. 5 years

#### Modem/GPS Unit

Dimensions (WxLxH)	100x70x40 mm (3.94 x 2.76 x 1.57 in)
Cable length	3 m (118 in)
Weight	350 g (0.77 lb)
Life span	approx. 5 years
Operating temperature	-20 to +50 °C (-4 to +122 °F)
Storage temperature	0 to +40 °C (+32 to +104 °F)
GSM unit	Quadband (850/900/1800/1900MHz),GPRS, EDGE
IP Protection Class	IP 65

#### Mat

Dimensions (WxLxH)	740x1050x25mm (29.13x41.33x0.98inch)
Weight	10 kg (22lb)
Life span	approx. 3 years
Operating temperature	-20 to +50 °C (-4 to +122 °F)
Storage temperature	0 to +40 °C (+32 to +104 °F)
IP Protection Class	IP65

#### BibTag

Dimensions (Width x Height)	100 x 30mm (3.94x1.18inch)
Max. speed	40 km/h (25 mph)
Max. detection height	approx. 2m (6.6ft)
Operating temperature	-20 to +50 °C (-4 to +122 °F)
Storage temperature	0 to +40 °C (+32 to +104 °F)
Protocol	EPCglobal Class 1, Gen 2 ISO 18000-6C
Power source	Integrated proprietary disposable battery
Operating frequency	860-960 MHz
IP Protection Class	IP 53

## 12.2. IO port pin settings

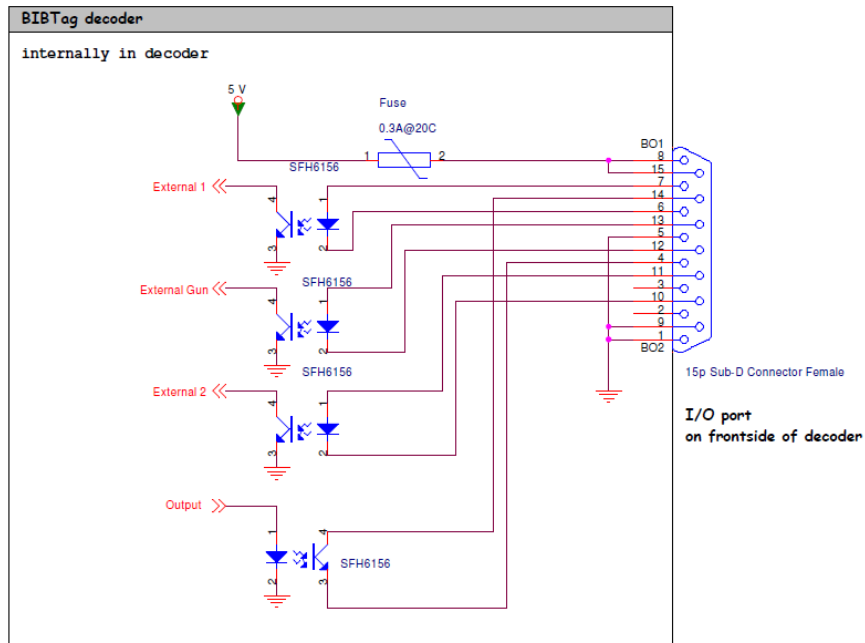

<p><b>External 1</b></p> <p>15p Sub-D Connector Male</p>	<ul style="list-style-type: none"> <li>- Connect pin 7 to pin 8 ( or 15 )</li> <li>- Connect pin 6 to terminal of button</li> <li>- Connect pin 5 to terminal of button</li> </ul>
<p><b>External Gun</b></p> <p>15p Sub-D Connector Male</p>	<ul style="list-style-type: none"> <li>- Connect pin 13 to pin 8 ( or 15 )</li> <li>- Connect pin 12 to terminal of start gun/button</li> <li>- Connect pin 5 to terminal of start gun/button</li> </ul>
<p><b>External 2</b></p> <p>15p Sub-D Connector Male</p>	<ul style="list-style-type: none"> <li>- Connect pin 11 to pin 8 ( or 15 )</li> <li>- Connect pin 10 to terminal of button</li> <li>- Connect pin 5 to terminal of button</li> </ul>

### 12.3. CE Declaration of Conformity

We,

MYLAPS  
Zuiderhoutlaan 4  
2012 PJ Haarlem, The Netherlands

Declare that the UHF system

#### **BibTag Portable Decoder**

In accordance with the following directives:

<b>2006/95/EC</b>	<b>The Low Voltage Directive</b>
<b>2004/108/EC</b>	<b>The Electromagnetic Compatibility Directive</b>
<b>1999/5/EC</b>	<b>Radio &amp; Telecommunications Terminal Equipment Directive</b>

Has been designed and manufactured to the following specifications:

**EN 301-489-1 (2005-09)**  
**EN 301-489-3 (2002-08)**  
**EN 302-208-2 (2008-04)**  
**EN 61000-3-2 (2006)**  
**EN 61000-3-3 (2008)**

I hereby declare that the product named above is designed to comply with the relevant sections of the above referenced specifications, and all essential requirements of the Directives.

Name of authorized person: John Verwoerd  
Function of authorized person: R & D Director  
Place and Date: Haarlem, 25 April 2017  
Signature of authorized person:

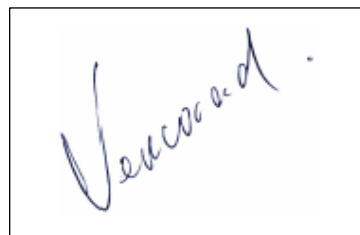

## 13. Support

In case you encounter any issues, please contact your sales offices:

MYLAPS EMEA Office

Haarlem, The Netherlands

Tel: +31 23 7600200

Email: [tech.support@mylaps.com](mailto:tech.support@mylaps.com)

MYLAPS Americas Office

Atlanta, USA

Tel: +1 (678) 816 4000

Email: [info.americas@mylaps.com](mailto:info.americas@mylaps.com)

MYLAPS Japan Office

Tokyo, Japan

Tel: +81 3 5275 4600

Email: [info.japan@mylaps.com](mailto:info.japan@mylaps.com)

MYLAPS APAC Office

Sydney, Australia

Tel: +61 (0)2 9546 2606

Email: [info.asia.pacific@mylaps.com](mailto:info.asia.pacific@mylaps.com)

MYLAPS Asia Office

Selangor, Malaysia

Tel: +60 (0)356131235

Email: [info.asia@mylaps.com](mailto:info.asia@mylaps.com)

MYLAPS 24/7

Only in cases of direct needed support for event organizers and companies.

Tel: +31 23 7600200